



metaLock[®]

by Delutech

SMART READER



MANUAL



TTLOCK APP



Scan to download the app

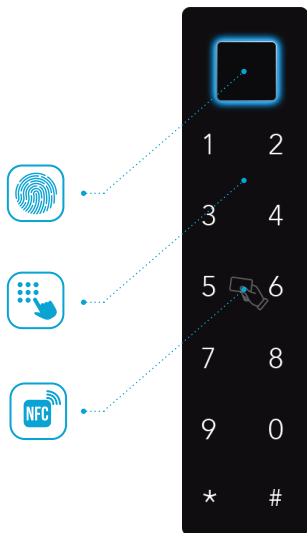

Manual

metaLock[®]

WIRING DIAGRAM

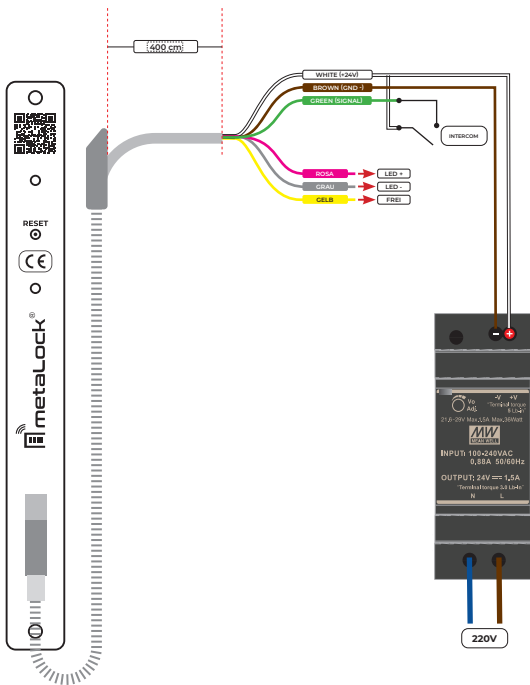

INTRODUCTION

The App is a smart lock management software developed by Shenzhen Smarter Intelligent Control Technology Co., Ltd. It includes door locks, parking locks, safe locks, bicycle locks, and more. The App communicates with the lock via Bluetooth BLE, and can unlock, lock, firmware upgrade, read operation records, etc. The Bluetooth key can also open the door lock through the watch. The application is multilingual.

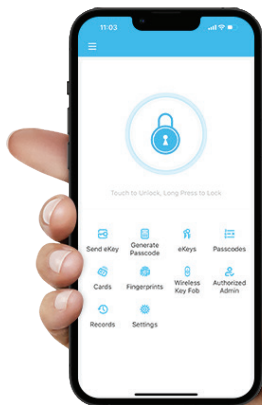

CONTENTS

REGISTRATION, AUTHENTICATION AND LOGIN	6
LOGIN SUCCESSFUL	7
LOCK MANAGEMENT	8
LOCK ADDING	9
LOCK UPGRADING AND TIME CALIBRATION	11
AUTHORIZED ADMINISTRATOR	12
SEARCH LOCK RECORD	12
KEY MANAGEMENT	13
PASSWORD MANAGER	14
PASSCODE MANAGER	16
CARD MANAGEMENT	17
FINGERPRINT MANAGEMENT	17
UNLOCK VIA BLUETOOTH	18
SYSTEM SETTINGS	18
PASSAGE MODE	19
ATTENDANCE MANAGEMENT	19
TRANSFER ADMIN RIGHT	20
GATEWAY MANAGEMENT	20
GATEWAY LIGHT STATUS	21
PAIR THE GATEWAY WITH APP	21

REGISTRATION, AUTHENTICATION AND LOGIN

Users can register the account by mobile phone and Email which currently support 200 countries and regions on the world. The verification code will be sent to user's mobile phone or email, and the registration will be successful after the verification.

13:12

Register

Email Phone

✉ Enter your Email

🔑 Password

🔑 Confirm Password

Verification Code

Your password must have 8-20 characters, and include a minimum of two types of numbers, letters and symbols

By Registering you agree to our Privacy Policy

13:12

Register

Email Phone

Country/Region Slovenia+386

👤 Enter your Phone number

🔑 Password

🔑 Confirm Password

Verification Code

Your password must have 8-20 characters, and include a minimum of two types of numbers, letters and symbols

By Registering you agree to our Privacy Policy

LOGIN SUCCESSFUL

The first time you use the lock lock app, if there is no lock or key data in the account, the home page will display the button to add the lock. If there is already a lock or key in the account, the lock information will be displayed.

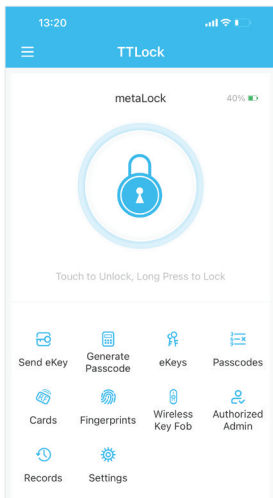
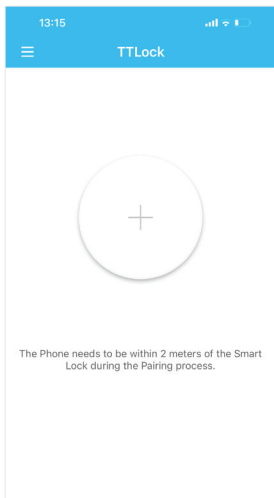

LOCK ADDING

The App supports multiple types of lock, including door locks, padlocks, safe locks, smart lock cylinders, parking locks, and bicycle locks. When adding a device, you must firstly select the lock type. The lock needs to be added to the app after entering the setting mode. A lock that has not been added will enter the setting mode as long as the lock keyboard is touched.

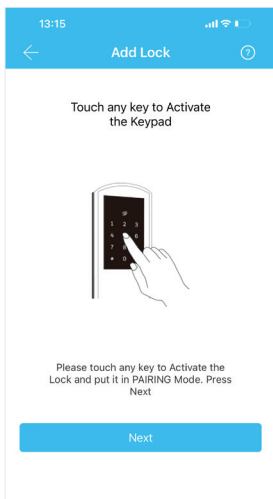
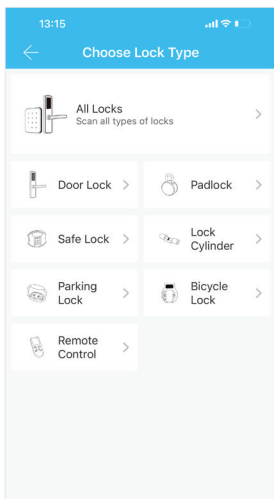

Assign a name to your lock and after you will see a main screen.

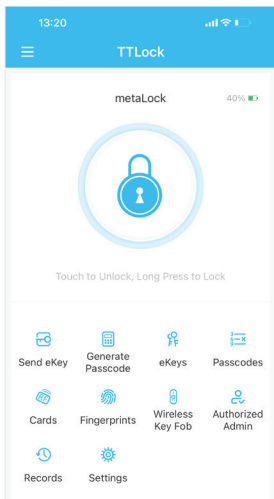
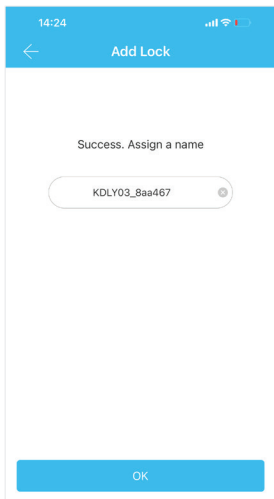

LOCK UPGRADING AND TIME CALIBRATION

User can upgrade the lock hardware on the APP. The upgrade needs to be done via Bluetooth next to the lock. When the upgrade is successful, the original key, pass-word, IC card, and fingerprint can continue to be used. If there is a gateway, the clock will be calibrated firstly through the gateway. If there is no gateway, it needs to be calibrated by the mobile phone Bluetooth.

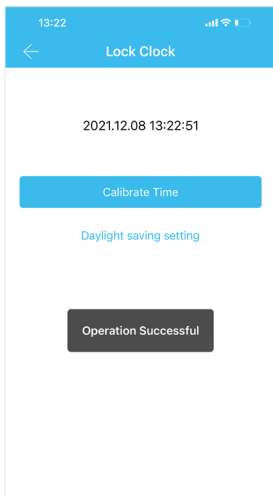
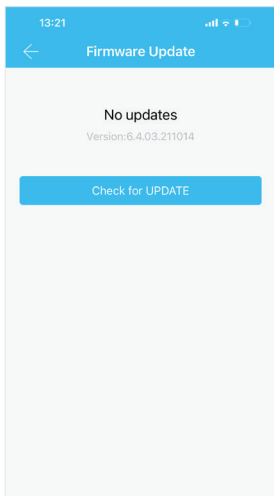

AUTHORIZED ADMINISTRATOR

Only the administrator can authorize the key. When the authorization is successful, the authorized key is consistent with the administrator's interface. He can send keys to others, send passwords, and more. However, the authorized administrator can no longer authorize others.

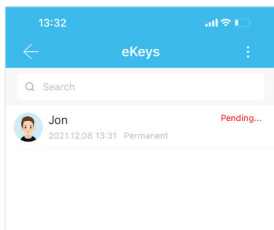
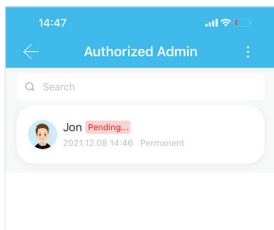

SEARCH LOCK RECORD

The administrator can query unlock record of each key.

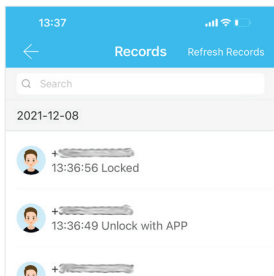

KEY MANAGEMENT

After the administrator successfully adds the lock, he owns the highest administrative rights to the lock. He can send keys to others. Meanwhile he can increase the key management that is about to expire. Click the type of lock it will show the time-limited ekey,

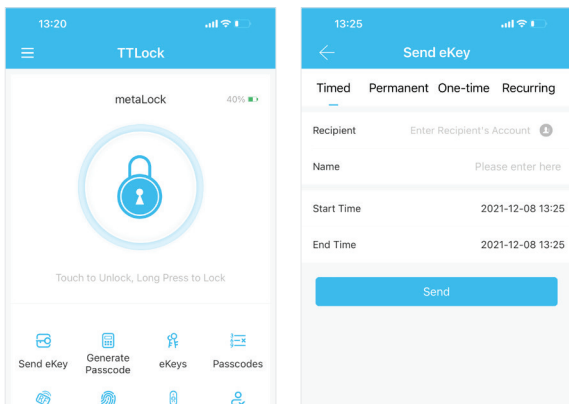

one-time ekey and permanent ekey. **Time-limited ekey:** The ekey is valid for the specified time, **Permanent ekey:** The ekey can be used permanently. **One-time ekey:** the ekey will be automatically deleted once it has been used. **Recurring ekey:** The key is working on specific days and times.

PASSCODE MANAGER

After inputting the passcode on the keyboard of the lock, press the unlock button to unlock. Passcodes are classified into permanent, time-limited, one-time, erase, custom, etc.

The screenshot shows the 'Generate Passcode' interface. At the top, there is a blue header with a back arrow and the text 'Generate Passcode'. Below the header, there are five tabs: 'Permanent', 'Timed', 'One-time', 'Erase', and 'Custom'. The 'Permanent' tab is selected and underlined. Below the tabs is a text input field labeled 'Name' with the placeholder text 'Enter a name for this passcode'. Underneath the input field is a warning message: 'This Passcode MUST BE used at least Once, within 24 Hours from Current Time, or it will be SUSPENDED for Security Reasons.' At the bottom of the screen is a blue 'Generate' button.

Permanent passcode

The permanent passcode must be used within 24 hours after it is generated, otherwise it will automatically expire.

The screenshot shows the 'Generate Passcode' interface. At the top, there is a blue header with a back arrow and the text 'Generate Passcode'. Below the header, there are five tabs: 'Permanent', 'Timed', 'One-time', 'Erase', and 'Custom'. The 'Timed' tab is selected and underlined. Below the tabs, there are two rows of fields: 'Start Time' with the value '2021-12-08 13:00' and 'End Time' with the value '2021-12-08 13:00'. Below these fields is a text input field labeled 'Name' with the placeholder text 'Enter a name for this passcode'. Underneath the input field is a warning message: 'This Passcode MUST BE used at least Once, within 24 Hours, after the Start Date and Time or it will be SUSPENDED for Security Reasons.' At the bottom of the screen is a blue 'Generate' button.

Time-limited passcode

The time-limited passcode can own an expiration date, which is a minimum of one hour and a maximum of three years. If the validity period is within one year, the time can be accurate to the hour; if the validity period is more than one year, the accuracy is month. When the time-limited passcode is valid, it should be used within 24 hours, otherwise it will automatically expire.

← Generate Passcode

Permanent Timed **One-time** Erase Custom

Name

This Passcode MUST BE used within 6 Hours from the Current Time or it will be SUSPENDED for Security Reasons. This Passcode can ONLY be used ONCE.

Generate

One-time passcode

One-time passcode can only be used for one time, and which is available for 6 hours.

← Generate Passcode

Permanent Timed One-time **Erase** Custom

Name

This Passcode is VALID for 24 Hours from the Current Time. Caution - All Passcodes used on this Lock will be DELETED on using this Passcode

Generate

Erase passcode

Erase passcode is used to delete all the passcodes the lock has set, and which is available for 24 hours.

← Generate Passcode

Permanent Timed One-time Erase **Custom** Recu

Permanent

Start Time 2021-12-08 13:00

End Time 2021-12-08 13:00

Name

Passcode 4 - 9 Digits in length

You can Configure the Customized Passcode via Bluetooth or Remotely via a Gateway.

Set Passcode

Custom passcode

User can set any passcodes and validity period he wants.

Recurring passcode

The recurring passcode can be reused within a specified time period, including daily type, weekday type, weekend type, and more.

PASSCODE MANAGER

All generated passcodes can be viewed and managed in the password management module. This includes the right of changing the password, deleting the password, resetting the password, and unlocking the password.

Name	Issue Date/Time	Validity
andreja	2021.12.08 13:38	Permanent
miha	2021.12.08 13:38	Permanent
andrej	2021.12.08 13:38	Permanent

Passcode	02397816
Name	andreja
Validity Period	Permanent
Issued by	[Redacted]
Time Issued	2021-12-08 13:38:40
Records	>
Delete	

CARD MANAGEMENT

You need to add the NFC card first. The whole process needs to be done via the app beside the lock. The validity period of the NFC card can be set, either permanent, time-limited or recurring.

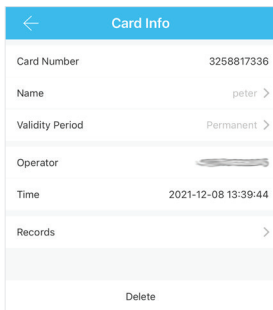
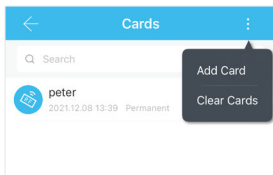
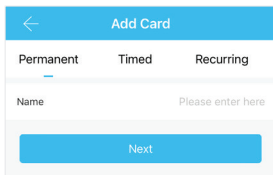

All NFC cards can be queried and managed through the card management module.

FINGERPRINT MANAGEMENT

Fingerprint management is similar to NFC card management. After adding a fingerprint, you can use the fingerprint to unlock the door.

UNLOCK VIA BLUETOOTH

App user can unlock the door via Bluetooth and can also send the Bluetooth ekey to anyone. Click the round button at the top of the page to

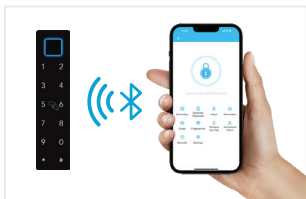

unlock the door and hold the round button to lock the door. Since the bluetooth signal has a certain coverage, please use the APP within the certain area.

SYSTEM SETTINGS

In the system settings, it includes touch unlock switch, group management, gateway management, security settings, reminder, transfer smart lock and so on.

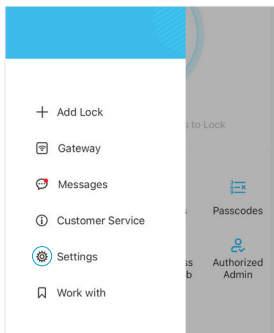

Touch to unlock

Touch unlock setting determines whether you can open the door by touching the lock.

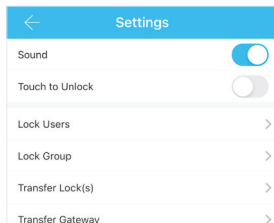

PASSAGE MODE

During the specific time period, the Lock will remain Unlocked until it is manually Locked.

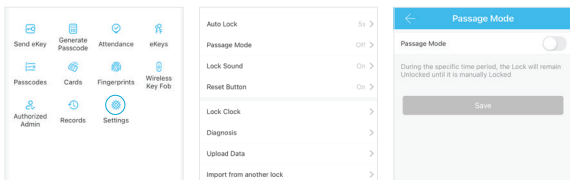

ATTENDANCE MANAGEMENT

The APP is access control, which can be used for company attendance management. The app contains functions of staff management, attendance statistics and so on. The normal door lock attendance function is turned off by default. The user can turn it on or off in the lock settings.

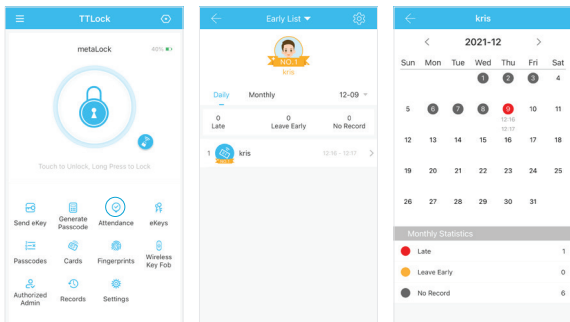

TRANSFER ADMIN RIGHTS

The administrator can transfer the lock to other users. Only the account that manages the lock has the right to transfer the lock.

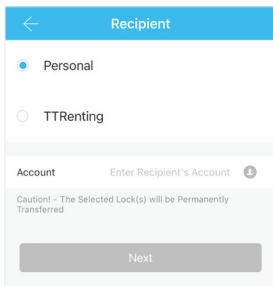
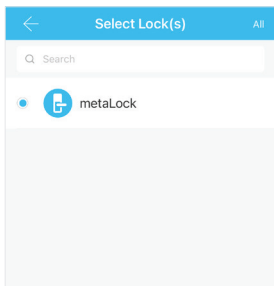

GATEWAY MANAGEMENT

The Smart lock is directly connected via Bluetooth, that is why it is not attacked by the network. The gateway is a bridge between smart locks and home WIFI networks. Through the gateway, the user can remotely view and calibrate the lock clock, read the unlock record. Meanwhile, it can remotely delete and modify the password.



LIGHT STATUS



When the gateway is powered on:



Light flashes alternately in red and blue: Stand-by mode, pairing mode



Blue light: Working mode



Red light: Network failure

PAIR THE GATEWAY WITH APP

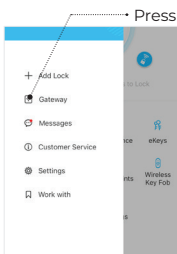
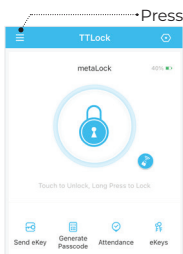

Connect to power



Connect to Wi-Fi

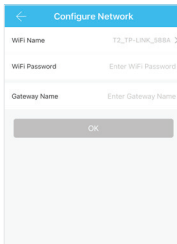

Pairing completed

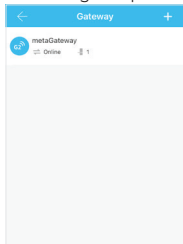

FCC STATEMENT

This device complies with Part 15 of the FCC Rules. Operation is subject to the following two conditions: (1) this device may not cause harmful interference, and (2) this device must accept any interference received, including interference that may cause undesired operation. Changes or modifications to this unit not expressly approved by the party responsible for compliance could void the user's authority to operate the equipment.

NOTE: This equipment has been tested and found to comply with the limits for a Class B digital device, pursuant to Part 15 of the FCC Rules. These limits are designed to provide reasonable protection against harmful interference in a residential installation. This equipment generates, uses and can radiate radio frequency energy and, if not installed and used in accordance with the instructions, may cause harmful interference to radio communications. However, there is no guarantee that interference will not occur in a particular installation. If this equipment does cause harmful interference to radio or television reception, which can be determined by turning the equipment off and on, the user is encouraged to try to correct the interference by one or more of the following measures:

- Reorient or relocate the receiving antenna.
- Increase the separation between the equipment and receiver.
- Connect the equipment into an outlet on a circuit different from that to which the receiver is connected.
- Consult the dealer or an experienced radio/TV technician for help.

This device and its antenna(s) must not be co-located or operation in conjunction with any other antenna or transmitter. This device complies with part 15 of the FCC Rules. Operation is subject to the following two conditions: (1) This device may not cause harmful interference, and (2) this device must accept any interference received, including interference that may cause undesired operation. This equipment complies with FCC radiation exposure limits set forth for an uncontrolled environment. This equipment should be installed and operated with minimum distance 20cm between the radiator and your body.



DELUTECH, d.o.o. • Spodnje gameljne 36a • 1211 Ljubljana - Šmartno
T: 059 / 031-021 • F: 059 / 017-781 • info@delutech.si • www.delutech.si